

Underfloor Heating Guide

HUNT HEATINGS COMPLETE HYDRONIC UNDERFLOOR HEATING SOLUTION



HUNT HEATING

UPONOR

WAVIN

GIACOMINI
Technology in Comfort



Clean, stylish and healthy.

Established in 1982, Hunt Heating has remained the leading supplier of hydronic products and solutions to the industry in Australia and New Zealand. With all our quality components, we can assure you of a hydronic system that will provide many years of economical comfort and service. Say goodbye to dust, ducts and noisy fans.

Welcome to the clean, silent world of hydronic heating.



Safe and comfortable.
 Silent and energy efficient.
 Design freedom.
 Low maintenance and reliable.
 A cleaner, greener environment.



CONTENTS

Introduction to Underfloor Heating	4
Underfloor Heating Methods & Solutions	5-6
Underfloor Heating System Components	7-8
Zonal Options	9
Combination Systems	10
SmartCalc Drawing and Quotation Service	11
Heat Sources	12-13
Heat Source Running Costs	14
Floor Coverings	15
Installer and Specifier Technical Information	
Expansion Joints	17
Thermal Bridging	17
Pipe Layout	17
Product Performance Data	18-19
Wiring Diagrams	20
Warranty & Indemnity	21

Introduction to **Underfloor Heating**

Due to its supreme level of comfort and great heating efficiency, underfloor heating has become the popular way to heat Australian homes.

The feeling of well-being is something we shouldn't take for granted. Feeling warm and comfortable in our homes helps maintain the feeling of well-being and promotes good health. There are numerous ways to experience warmth but only a few that guarantee real comfort.

Benefit from our expertise in underfloor heating system solutions. Radiant energy emitted by the floor is partly reflected by each surface and partly absorbed. Where it is absorbed, that surface becomes a secondary emitter. After a while, all surfaces become secondary emitters. Furnishings themselves radiate energy and the room becomes evenly and uniformly warmed. The energy and heat reaches into every corner of the room – no cold spot, no hot ceilings and no cold feet.

Our manufacturing research and development operations have allowed our product range to be created with the local climate, codes and building practices in mind. Equally, this enables the product range to evolve in quick response to future local market changes. Through the Hunt Heating training process, installers obtain a complete understanding of the system and procedures for a compliant installation.



Simple,
clean &
efficient.



Underfloor Heating Methods & Solutions

Before choosing underfloor heating, many factors need to be considered; one of, if not the most important of which, is floor construction.

IN SLAB

In slab floor heating turns your whole floor into a radiant heater, producing that amazingly comfortable warm home that hydronic floor heating is known for.

In slab floor heating is the standard method for hydronic underfloor heating.

Pipes are secured to metal reinforcement 200mm apart, in either a spiral or serpentine layout at lengths no more than 100m. Concrete is then poured, encompassing the underfloor pipe, creating a structural slab to build on.

When connected, heated water will flow through the underfloor pipework, transferring heat into the concrete, in turn radiating heat to within the property.

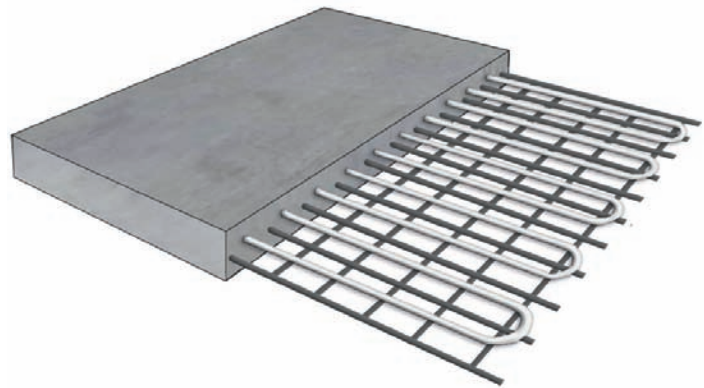

IN SCREED

In screed floor hydronic heating is the most efficient and responsive method of under floor hydronic heating, it can be installed in both new and existing homes. Like structural floor heating, in screed heating turns your whole floor into a radiant heater, producing that amazingly comfortable warm home that hydronic floor heating is known for, but does it in a far more responsive and efficient way.

Under floor heating pipe is located and secured into Pipe Positioning Board, at a distance of 200mm apart, which is laid directly on top of a pre poured structural slab. The under floor heating pipe and Pipe Positioning Board are then screeded over with a minimum of 50mm thick concrete screed.

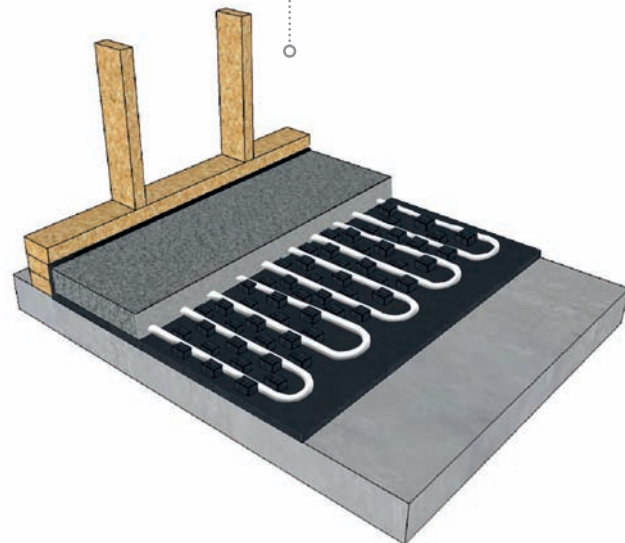

Underfloor Heating Methods & Solutions

(CONTINUED)

SUSPENDED FLOOR

This method of underfloor heating is facilitated by securing a long, thin sheet of Aluminium called 'Heat Emission Plate', between floor joists, with floor boards laid directly on top. Heat Emission Plate has a groove running along its centre line, designed to locate and secure our specialist PEX-a underfloor heating pipe in place, sandwiching the pipe between Heat Emission Plate and floor boards. A slimmer version of Heat Emission Plate can also be secured directly to the underside of floor boards under an existing floor between joists.

Heat Emission Plate is designed to conduct heat energy from the underfloor heating pipe that's located within, creating a larger heat transfer surface area.



MINITEC SYSTEM (SHALLOW SCREED)

The Minitec System installations are designed for renovations or retrofitting of underfloor heating on an existing building. A thin, rigid plastic sheet is placed on top of existing flooring and the pipework is then laid within. Raised knuckles allow for easy placement of pipework making the installation quick and easy. After pipework is laid, a self levelling compound is poured on top, to a height just over the knuckles.

The perforation in the knuckles ensure perfect adhesion of levelling compound to the base level below. Due to the minimal height of the panel, the shallow depth method means the floor level is only raised around 15mm (plus flooring).

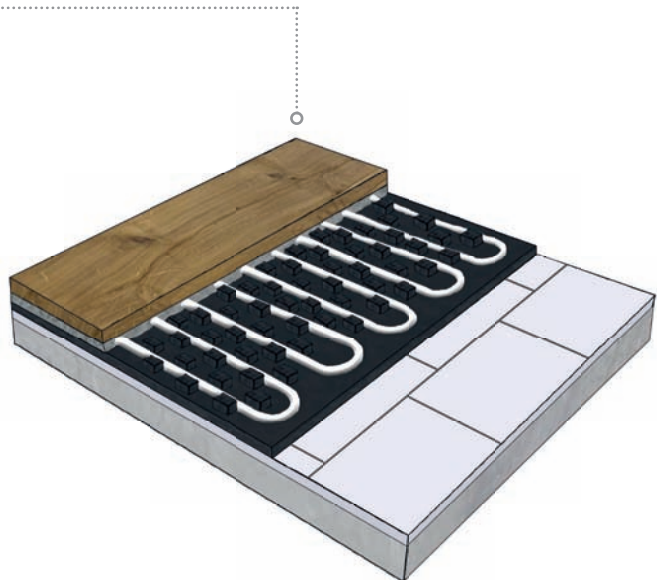

Underfloor Heating System Components

PEX-A PIPE

PEX-A underfloor heating pipe is one of the most flexible and durable pipe's on the market, with a bend radius of as little as 250mm for a 16mm pipe. The main and thickest layer is the inner, made up of a PEX-A (polyethylene) crosslinked section.

Our PEX-A underfloor heating pipe is also manufactured with an ever so important EVOH oxygen barrier, which completely surrounds the inner PEX-A layer.

This EVOH layer prevents air from penetrating the pipe and entering the heating system.

Unlike many other underfloor heating pipes, the oxygen barrier is protected with an external layer of PERT (Polyethylene Raised Temperature). The external PERT layer gives extra protection and aids in the resistance to abrasions and markings, meaning the pipework can withstand rough treatment on site.

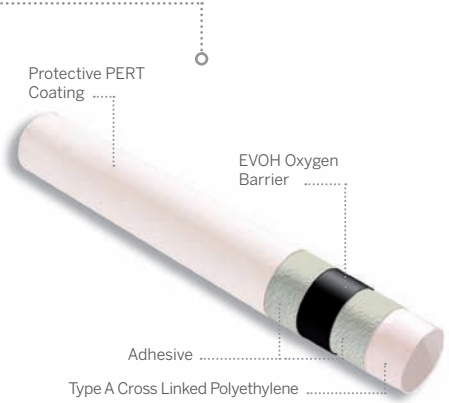

MANIFOLDS

Underfloor heating manifolds are an essential component of any hydronic underfloor heating system. Our composite, modular manifolds are manufactured from Glass Fibre Reinforced Black Polyamide (GRBP), providing both a means of water distribution and water flow regulation.

Manifolds are supplied water from the heat source via pipework which can be connected either from left or right, by simply rotating the manifold

around to suit system design. Manifolds are supplied with; 1" ball valves, air bleeds, wall brackets, drain cocks, flow regulators and temperature gauges. Optional extras include free standing support frames and electric actuators.

Each modular port on the manifold is threaded, allowing them to lock together in both vertical planes, 180° different to one another. This allows simple connection to circuits located above and below the manifold.



MANIFOLD MIXING

A Manifold Mixing station is simple but effective way of reducing flow delivery temperature to an underfloor heating manifold, whilst maintaining flow rate. Typical use would be on a system with high temperature panel radiators as well as low temperature under floor heating. Supplied preassembled, the mixing station comes complete with brass

3-way mixing valve, wall bracket, capillary sensing pocket, over heat interlock, pump, non-return valve, 1" flow and return connections. Optional extras include; thermostatic control head including capillary sensor and an electronic mixing actuator.



Underfloor Heating System Components

(CONTINUED)

PIPE POSITIONING BOARD

Pipe Positioning Board is one of the most significant developments in modern times, if installed during construction; positioned directly onto a pre-poured structural slab, pipework installed then screeded over. The thermal and acoustic properties of Pipe Positioning Board, mean reaction time of the slab is reduced significantly, in turn reducing energy bills significantly.

Achieving a thermal resistance (R) value of 1, Pipe Positioning Board is made of sintered foam polystyrene, in accordance with EN13163.

37 mm in total thickness, made up of 15mm sheet, 22mm mushroom, Pipe Positioning Board is extremely quick and easy to install; thanks to the tongue and groove system surrounding each panel, polystyrenes light weight properties and ease to shape.

Laying underfloor heating pipe is also made easier, with 22mm mushrooms pipe is loaded and secured into the board, not on top, protecting it during concreting. With 50mm centres accurate and even pipe layouts are easily achievable.



HEAT EMISSION PLATE

Aluminium Heat Emission Plate used to facilitate suspended floor heating, secured to joists or directly under timber floor boards will maximise the heat transfer area of the underfloor heating pipe running its length.

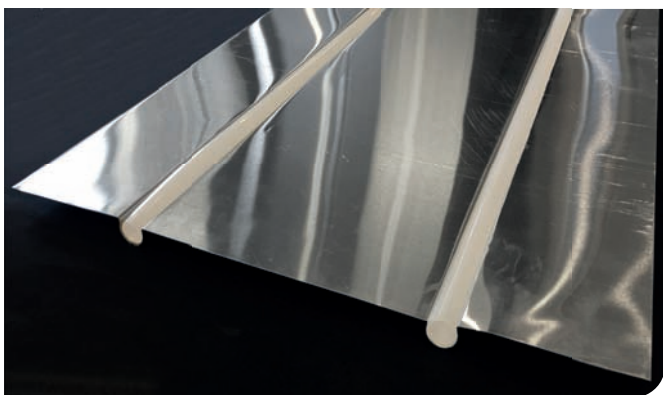

MINITEC SYSTEM

With a minimal depth of around 1cm, Minitec is an ideal system for renovation projects. The Minitec sheeting element with specialised PEX-A pipes measuring 9.9 x 1.1 mm, is easy to lay on existing screed, timber or tiles. The adhesive layer on the back of the sheet guarantees a secure bond during installation. The leveling layer is installed just above the raised knuckles, resulting in an increase in floor height of only 15 mm.

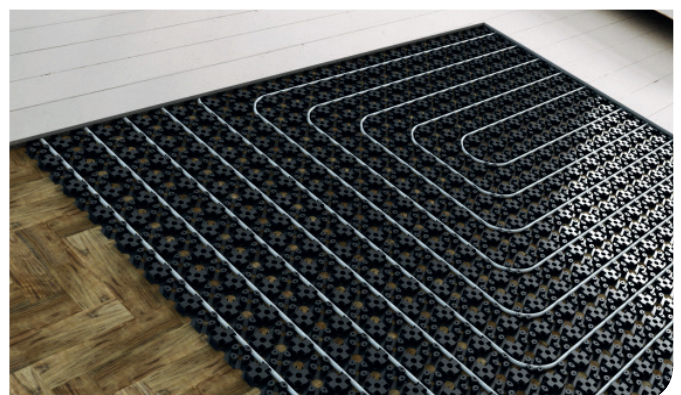

Zonal Options

Underfloor heating controls allow heating systems to run automatically, with virtually no input from the user. The basic functionality of the control system is to switch the heat source on and off as required, and direct heat to where its required by opening and closing valves.

ACTUATORS

Actuators are used to electronically open and close under floor heating circuits, controlling the delivery of heated water to particular zones, in turn regulating the temperature of these zones. Actuators are fixed directly to an underfloor heating manifold and operated via a thermostat and wiring centre.



WIRING CENTRE

A Wiring Centre is an essential component required to zone an underfloor heating system. Connecting thermostats, actuators and heat source together, the wiring centre controls the on/off operation of the system.



THERMOSTAT

Indoor room thermostats placed strategically allow for zone by zone comfort control, turning circuits on and off. Both programmable and non-programmable versions are available.

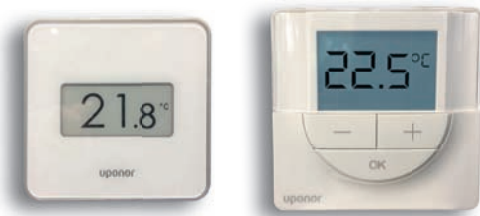

FLOOR TEMPERATURE SENSOR

Optional floor temperature sensors can be incorporated with a room thermostat to control the minimum and maximum temperature of the actual floor, while still maintaining the room temperature set on the thermostat.



MULTI ZONE CONTROL

Underfloor heating systems are customisable, with zones that can be setup and regulated to different comfort settings.

Thermostats are operated and setup by occupants, which will regulate the dwellings ambient air temperature according to what the occupants have requested by sending on/off commands to a wiring centre.

The wiring centre opens/closes relevant electronic actuator/s and also commands the heat source to turn on/off starting the flow of heated water to the manifold, then round the requested circuits.

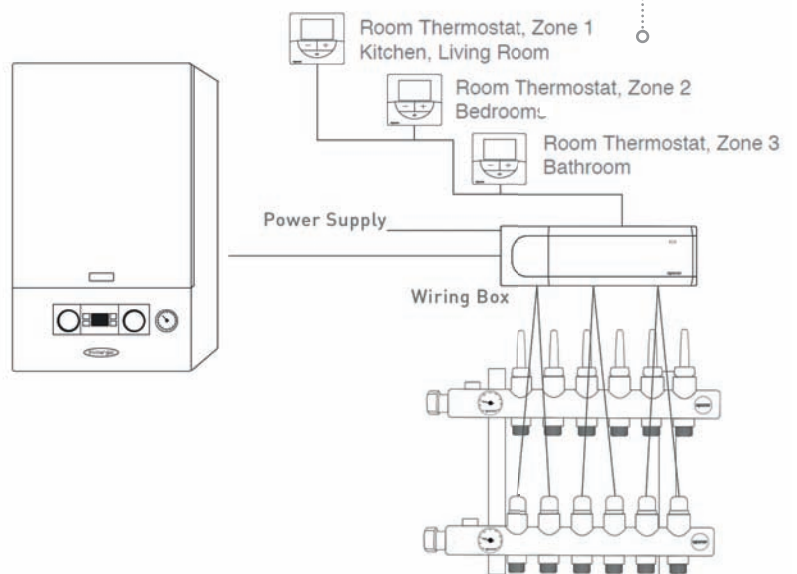

Combination Systems

INCORPORATING RADIATORS INTO AN UNDERFLOOR SYSTEM

Panel radiators running on high temperature water and underfloor heating running on low temperature water can both be combined on to the same system. A typical scenario would be the use of panel radiators upstairs and under floor heating down stairs in a two storey home.

What used to be a relatively complex system is now easy to achieve using a Partage Box. Partage Boxes are available in different configurations, meaning systems can be fully customised to suit the layout and

customer requirements partage boxes are also compatible with a full range of different heat sources.

Partage boxes can also be used to zone heating systems, whether it be a complete panel system of complete underfloor heating system, where each zone will have its own individual thermostat. A typical scenario would be a three storey property, with underfloor heating on each floor controlled individually by their own thermostat.

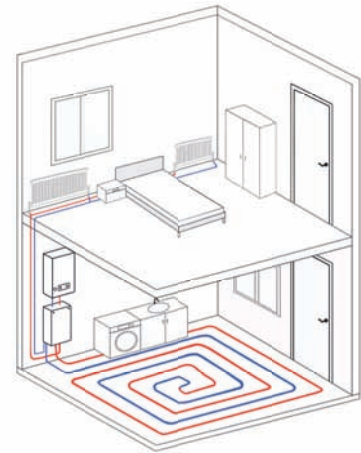

PARTAGE BOXES

Models available:

- DIM^{v2} BASE - 1 zone
Hydraulic manifold and 1 pump
- DIM^{v2} 2 ZONE - 2 equal temperature zones
Hydraulic manifold, 2 pumps & electronic board
- DIM^{v2} 3 ZONE - 3 equal temperature zones
Hydraulic manifold, 3 pumps & electronic board
- DIM^{v2} H-LT - 1 high temperature zone & 1 low temperature zone
Hydraulic manifold, 2 pumps, 1 mixing valve & electronic board
- DIM^{v2} H-2LT - 2 high/1 low temperature zones or 1 high/2 low temperature zones
Hydraulic manifold, 3 pumps, 2 mixing valves & electronic board



Our team of hydronic heating experts take a holistic approach at the consultation phase, and will take into consideration all aspects of your home, including outdoor temperatures, external walls, insulation levels, and whether or not any adjacent rooms in your home are already heated.

Through a combination of the latest software and the expertise of our Customer Service Team, you can rest easy knowing that we'll design a bespoke solution that delivers superior comfort but is also completely environmentally friendly and energy efficient.

Whether you're looking at installing underfloor heating in conjunction with radiators, or you'd like a combination boiler that takes care of your entire home's hot water requirements, we can tailor a solution that works for you. We use only the leading products on the market, including Italian-made Immergas boilers, which are renowned for their power, durability and efficiency.

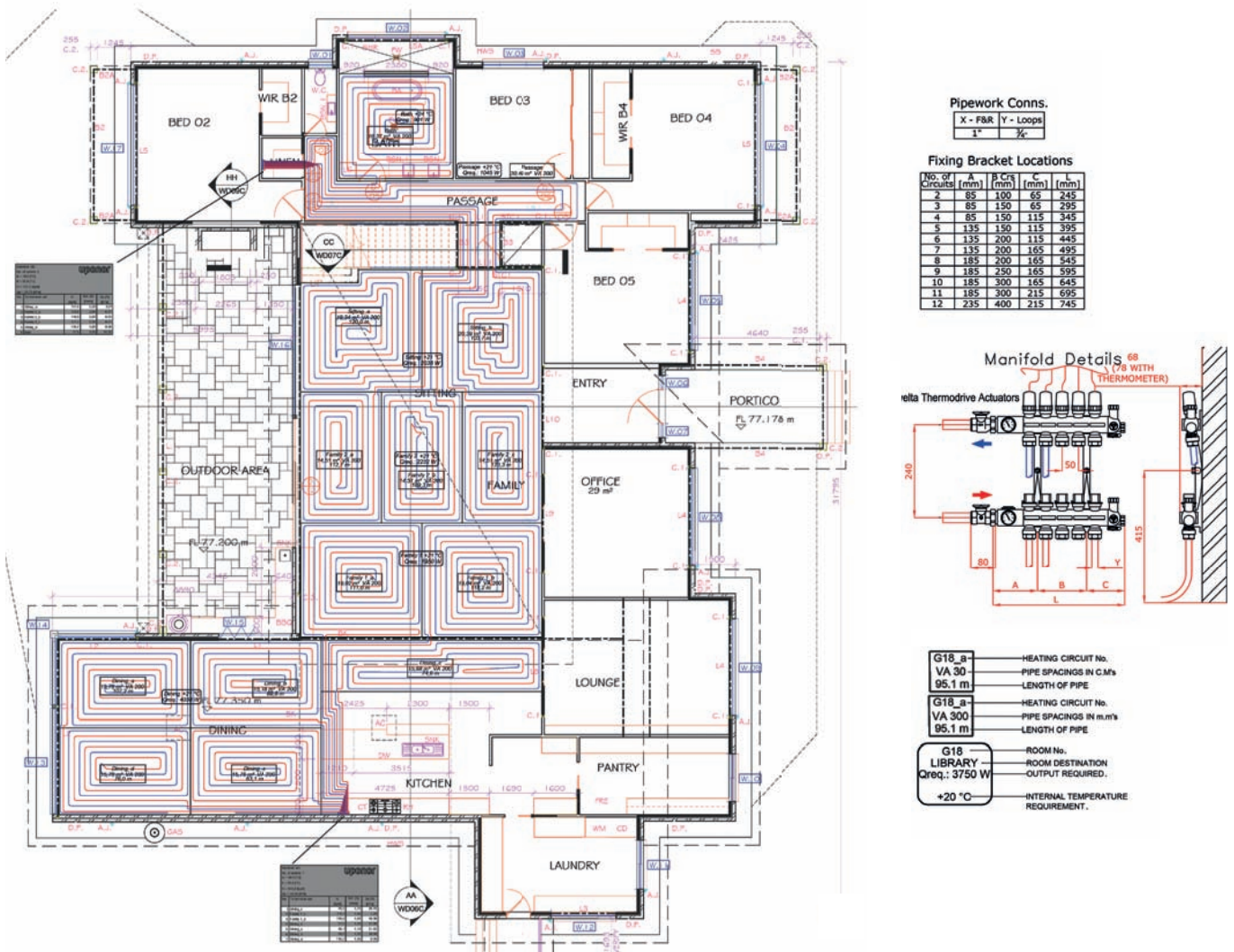

Using our software and expertise the design of an underfloor heating system is a straight forward process consisting of 6 main steps:

- Calculate heat losses and amount of heat required for each room or zone
- Determine water flow temperature and pipe spacing
- Determine manifold location
- Calculate number of circuits required
- Plan pipe layout
- Calculating the capacity of an underfloor heating system

Heat Sources

NATURAL GAS & LPG BOILER

Our certified range of boilers available in natural gas and LPG, with both internal & external installation options, the Immergas boiler range provides full flexibility to suit any situation. On top of the 32kW standard efficiency model, the high efficiency condensing range will provide excellent efficiency ratings of more than 98%.

For larger homes and commercial environments, including aged care facilities, hospitals and education buildings, our large fully condensing cascade solutions are the perfect solution to provide maximum outputs with minimum fuss. Multiple installation options and minimal footprint mean they can be tailored to suit any scenario.

As well as heating only boilers, our Condensing combination boilers enable a single boiler to produce continuous flow domestic hot water, whilst also managing the delivery of hydronic heating.



AIR TO WATER HEAT PUMP (ELECTRIC)

Heat pumps allow for more advanced solutions of heating and cooling, with a further option to combine domestic hot water production.

Immergas air-water heat pumps use external air as a renewable energy source. Excellent for cooling and heating homes, offices and new buildings, they provide one of the best solutions in terms of energy efficiency, low running costs and reduction of polluting emissions.

Supplied with low consumption system pump, fully modulating fans, pre-charged R410a refrigerant gas, remote control, condensate drain fitting and in-line strainer. With 3 x single-phase and 3 x three phase versions available, the Immergas Heat Pump is the ideal solution for stand-alone systems or as a combination with integrated equipment and hybrid solutions.



Heat Sources

(CONTINUED)

WOOD PELLET BOILER

MCZ's range of wood pellet boilers are available with power outputs from 22kW – 35kW, supplied with internal pumps and expansion vessels. The range comes complete with everything required to deliver hydronic heating and domestic hot water, effectively and sustainably.

Stocked by Hunt Heating along with a full range of twin skin, insulated stainless steel flue for safe and easy internal or external flue installation.

Available in a range of both traditional and modern finishes to suit any style.



DIESEL BOILER

Manufactured in Ireland, Firebird is a leader in innovative technologies and efficiency, offering a full range of internal and external high efficient, fully modulating condensing diesel boilers from 26kw – 100kw, designed for both open and sealed systems.

Built from premium quality steels with multiple flow and return connections points for ease of installation all whilst running on standard diesel fuel.

Controlled automatically by thermostats and timers, running for months with virtually no attention.



ELECTRIC BOILER

Kospel EKCO electric boilers are conveniently offered in a range of single and three phase boilers, with power outputs ranging from 8Kw – 24Kw.

Powered by electricity only, the Ekco does not emit waste and therefore doesn't require installation of any flues or chimneys.

Complete with an internal pump and expansion vessel, the internal EKCO boiler is silent in its operation and able to deliver both hydronic heating and domestic hot water through a storage tank using a 3-way valve.



Heat Sources Running Costs

Running costs are a key consideration and one which can be challenging to answer due to the variability in types of fuels and prices. Actual cost of heating will depend on the area heated, running time, thermostat settings, house insulation, energy tariffs and the local climate. The costing graph below is based on the following typical heat load.

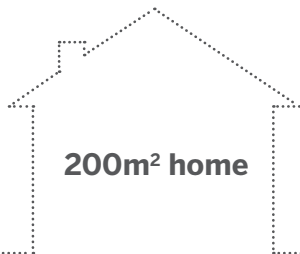

@ 20Kw heat load, operating for 8 hours a day for 120 days a year

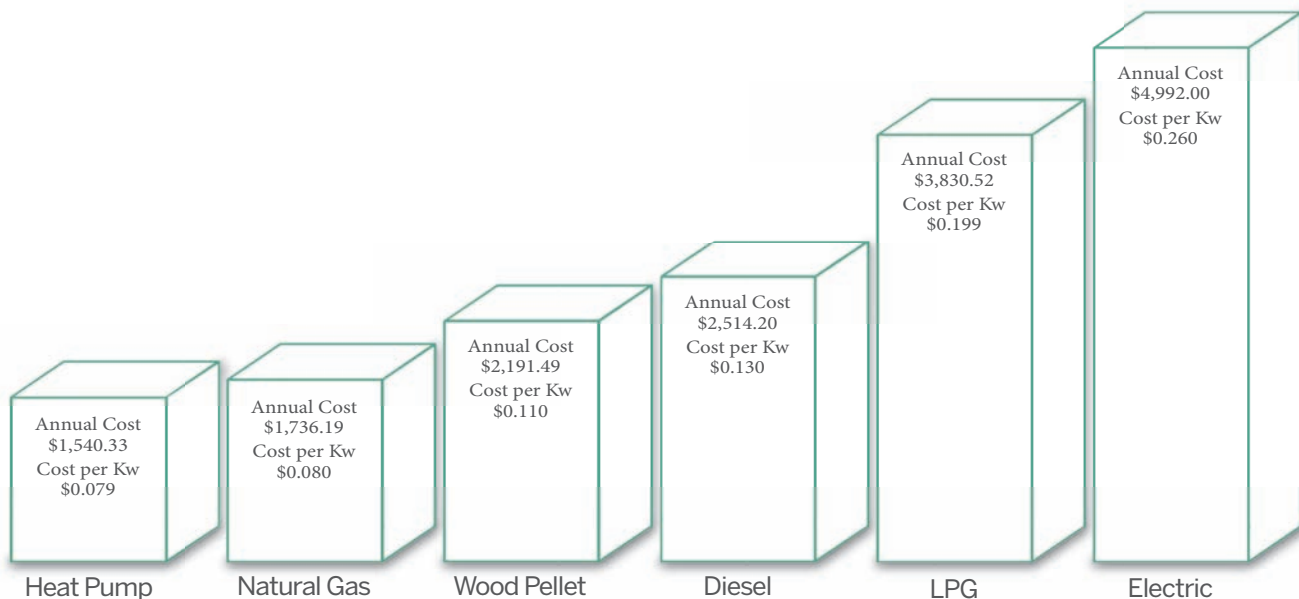

Heat Source Outputs & Cost Per Unit

- Heat Pump - three phase 21Kw based on 45° Water Flow Temp & 7° Day
\$0.2601 per KW
- Natural Gas Boiler - condensing 30Kw
\$0.0223 per MJ
- LPG Boiler - condensing 30Kw
\$1.23 per Litre
- Diesel Boiler - 26Kw
\$1.18 per Litre
- Wood Pellet Boiler - 22Kw
\$0.52 per KG
- Electric Boiler - Three phase 24Kw
\$0.2601 per KW

Running Cost Calculation Example - Wood Pellet

22.3 kw maximum power = 4.9 kg/h

1 kg of wood pellets = \$0.52

- To receive the required 20 kw the system needs 4.39 kg of wood pellets per hour
- 4.39 kg/h running at eight hour = 35.12 kg used per day
- 35.12 kg of pellets per day across a 120 day (4 month) period = 4,214.4 kg
- 4,214.4 kg & \$0.5 = **\$2,191.49 annually**

Please Note:

- Figures accurate as of 1st August 2017 and should be used as example only
- Excludes supply, rental and delivery charges
- Excludes on time payment, member discounts and government subsidies (eg agricultural diesel)
- Excludes GST

Floor Coverings

The main difference between flooring types and their suitability for use with underfloor heating is the materials thermal conductivity - meaning how quickly and efficiently heat generated transfers to the floor surface.

TIMBER

Different types of wood flooring have different thermal properties, as such there are differences in their suitability for use with an underfloor heating system. The more dense and the thinner the floor boards are, the better they conduct heat and typically more suitable they are for use.

CONCRETE

Polished concrete is an ideal finish for underfloor heating. The concrete is the direct conductor of the heat energy that is transferring into the room, combined with high thermal mass allows for full benefit of the underfloor heating system.

CARPET

Carpet is suitable for use, provided carpet or underlay does not act as an insulator blocking the heat. Most carpets can be used, however wool or high pile is a thermal insulator and will slow the transfer of heat from floor to the air above, the thicker the carpet the greater the thermal resistance

TILE & STONE

Similar to concrete, tiled and stoned flooring are one of the most suitable finishes as they have high thermal mass and good conductivity. Heat from the pipes can quickly transfer to the surface and increasing the thickness wont affect the output.

Tiles can be heated to 29°C or more, meaning that you can also achieve one of the highest heat outputs.



*For more information Hunt Heating recommends conferring with flooring manufacturer, prior to installation, regarding suitability for use with underfloor heating systems.

Installer & Specifier Technical Information

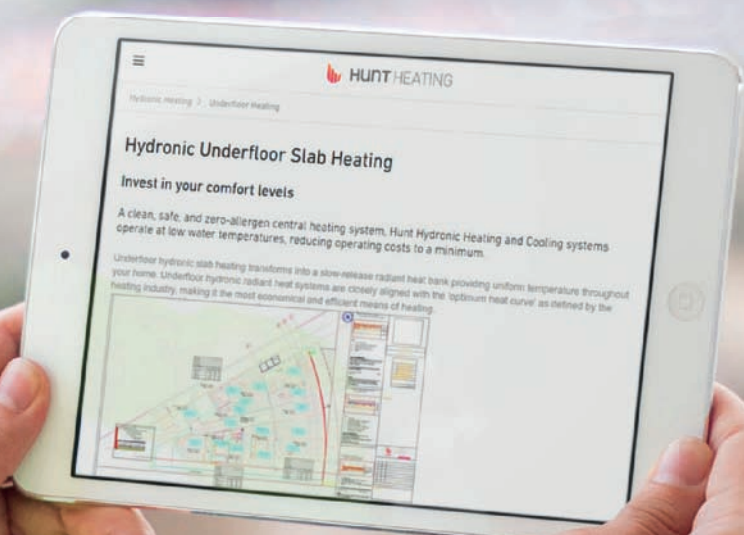

Installer & Specifier

Technical Information

EXPANSION JOINTS

As concrete over an underfloor heating system dries, there is a potential for movements with the changes in temperature. In order to protect the floor by preventing cracking, expansion joints should be fitted during installation.

It is important the pipes are laid before the joint is fixed in place, otherwise laying the pipe underneath may be difficult. However, when pipe layout plans are being formulated, try to take expansion joints onto consideration and avoid running pipework through such joints.

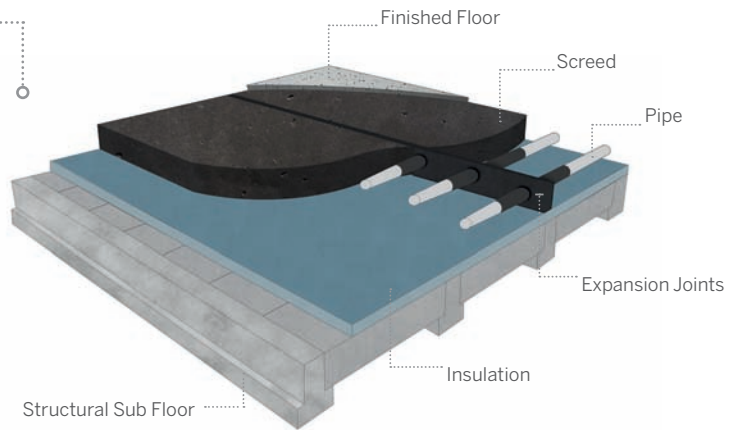

THERMAL BRIDGING

Thermal bridging can take place from the heated slab to anything that it comes directly in contact with, causing unnecessary heat loss.

To stop or reduce heat loss in this way, we recommend using insulation to create a thermal break between the main heated slab and any surface it comes in contact with, cutting out heat loss entirely (fig 2). A great way to facilitate this is to use Pipe Positioning Board.

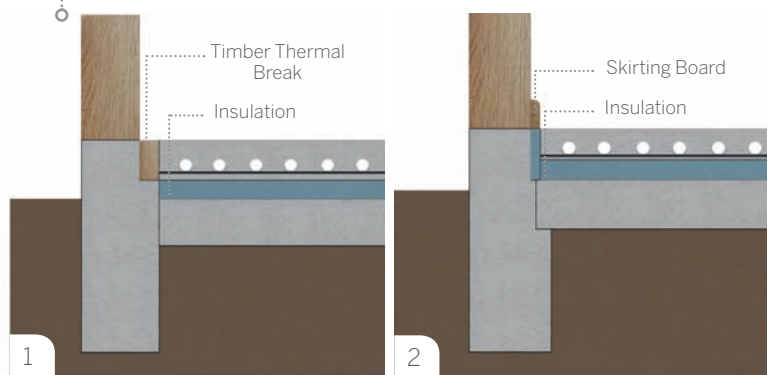

PIPE LAYOUT

When installing underfloor heating, installers choose from two pipe configurations; spiral and serpentine. The type of configuration used depends on the size and complexity of the area being heated, however the preferred method is always the spiral.

In general when pipe layout plans are being formulated, the flow pipe (hottest) should be laid closest to the room wall then spiral inwards towards the centre of the room, this will give an even distribution of heat across the floor area. Flow and return pipes in and out of room should always pass through doorways, never under walls or windows.

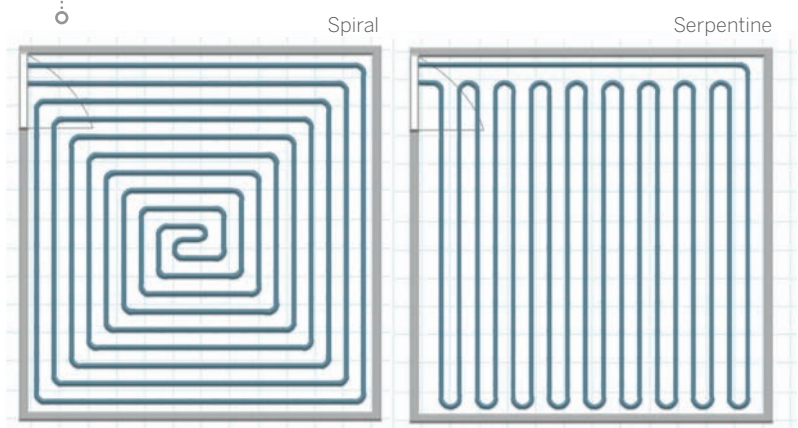

*For more information on the requirements of expansion joints, thermal bridging and pipe layouts Hunt Heating recommends seeking advice from a builder.

Installer & Specifier

Technical Information

(CONTINUED)

PRODUCT PERFORMANCE DATA

Uponor PEX-A Pipe Specifications

Size	16mm diameter x 2mm wall
Supplied in	Boxed 240m coils
Colour	White
Complies with	25 Year Warranty
Warranty	Produced in accordance with EN ISO 15875-2 (Application class 4/8 bar according to ISO 10508)

Giacomini Pipe Positioning Board Specifications

Product code	R982QY013
Effective dimensions	1400 x 800 mm
Effective surface	1,12 m ²
Panel dimensions	1450 x 850 mm
Panel surface	1,23 m ²
Total thickness	37 mm sheet: 15 mm + mushroom: 22 mm
Pipe diameter	15-18 mm
Allowed pitches	Multiples of 50 mm
Quantity of piping per m²	100 mm pitch: 10 m & 150 mm pitch: 6,67 m
Material Sintered	Foam polystyrene PS30 (EPS150)
Application range	30 kg/m ³
Thermal conductivity, D	0,034 W/(m K)
Thermal resistance R	1,00 m ² K/W
Minimum compression resistance at 10% crushing	150 kPa (1,5 kg/cm ²)
Classification	EPS-EN13163-T1-L1-W1-S1-P3 DS(N)5-DLT(1)5-BS250-CS(10)150

Installer & Specifier Technical Information

(CONTINUED)

PRODUCT PERFORMANCE DATA (CONTINUED)

Uponor Manifold Specifications

Connection dimensions	2 x 1" mains flow and return
Max. operating temperature	60°C
Max. operating pressure	6 bar
Max. test pressure (24 h, ≤ 30°C)	10 bar
Max. water quantity per distributor	3.5 m ³ /h
kvs value inlet/outlet valves	1.2 m ³ /h
Adaptable thermo drives	TA 230, TA 24, DDC, TR-D 12
Available sizes	2 - 12 heating circuit connections

Uponor Thermostat Specifications

ERP (thermostat only)	IV
Low voltage tests	EN 60730-1 and EN 60730-2-9
EMC tests	EN 60730-1
Power supply	From wiring centre
Voltage	4.5 V to 5.5 V
Operating temperature	0 °C to +45 °C
Storage temperature	-10 °C to +70 °C
Connection terminals (thermostats only)	0.5 mm ² to 2.5 mm ²

Uponor Wiring Centre Specifications (see following page for diagram)

Low voltage tests	EN 60730-1 and EN 60730-2-1
EMC tests	EN 60730-1
Power supply	230 V AC +10/-15%, 50 Hz or 60 Hz
Internal fuse	F3.15AL 250 V, 5x20 3.15A quick acting
Internal fuse, Heat pump output	TR5-T 8.5 mm Wickmann 100 mA Time lag
Operating temperature	0 °C to +45 °C
Storage temperature	-20 °C to +70 °C
Maximum consumption (Base)	40 W
Pump and boiler relay outputs	230 V AC +10/-15%, 250 V AC 8 A maximum
General purpose input (GPI)	Only dry contact
Valve outputs	24 V AC, 0.2 A average, 0.4 A peak
Connection terminals for power, pump, GPI & boiler	Up to 4.0 mm ² solid, or 2.5 mm ² flexible with ferrules
Connection terminals for bus communication	0.5 mm ² to 2.5 mm ²
Connection terminals for valve outputs	0.2 mm ² to 1.5 mm ²

Installer & Specifier Technical Information

(CONTINUED)

UPONOR WIRING CENTRE TYPICAL DIAGRAM

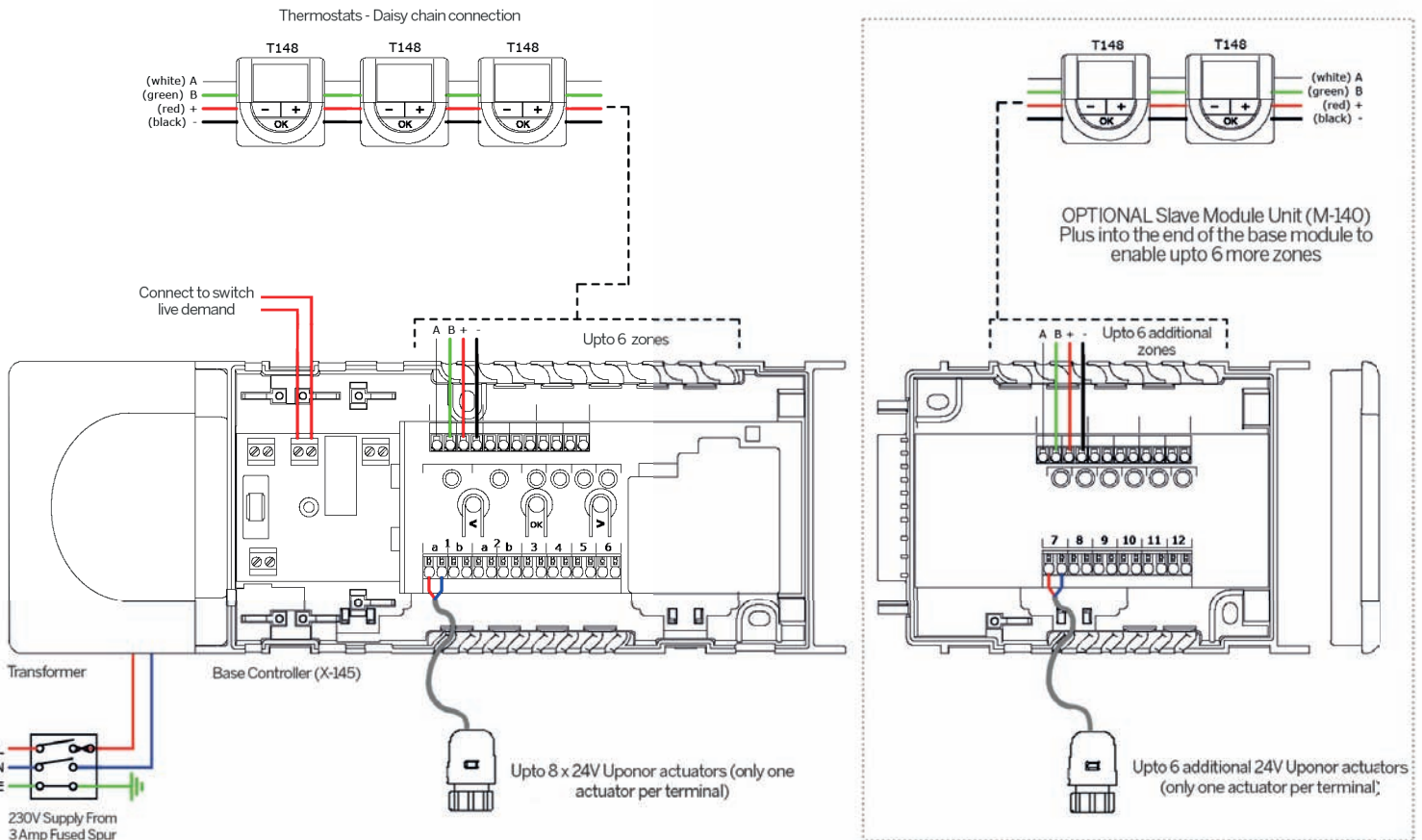

Warranty & Indemnity

WHY CHOOSE HUNT HEATING?

Hunt Heating has been designing and supplying warm water underfloor heating for more than 30 years. Our systems are all designed in-house to meet specific needs and every project, regardless of size, is overseen by our experts from start to finish. We are committed to offering every customer:

- **Genuine, helpful advice and a high level of support**

Our experts are here to help you throughout, from the initial stages of choosing the right solution, right through to post installation technical support with full commissioning service available. Our Technical Support Team will oversee the project and aside from speaking with us over the phone you are also able to visit us in the office, or we can send one of our experienced team out to meet you on site.

- **High quality heating solutions**

Hunt Heating uses the highest quality, tried and tested components for our UFH and cooling systems and our in-house Product Development Team is continuously working to ensure that we offer the very best heating solutions in the market.

- **A bespoke approach**

Each Hunt Heating system is meticulously designed to warm each room in a property to the desired temperature, both maximising comfort and minimising energy consumption. We achieve this high level of performance by creating a bespoke system design for every project.

QUALITY PRODUCTS WITH EXTENSIVE WARRANTIES

Hunt Heating uses the highest quality, tried and tested components for our underfloor heating and renewable systems. Because of this, we offer long warranty periods to give you complete confidence.

- **PEX-a Pipe**
30 year product warranty - first 6 years insurance backed, covering complete cost of the remedial works & reinstatement
- **Underfloor Heating Manifold**
10 year warranty
- **Multi-zone Partage Boxes**
2 year warranty
- **Electrical Components** (wiring centres, manifold actuators, thermostats, pumps & ancillary electrical components)
2 year warranty
- **Plumbing Components** (manifold valves and gauges)
2 year warranty

COMPREHENSIVE INSURANCE

Professional Indemnity to the value of \$5 million to guarantee design.

In the event that a client suffers financial loss as a result of alleged neglect, error or omission in design, Professional Indemnity Insurance will meet the cost of defending claims and any damages payable.

Public Liability to the value of \$20 million.

Public Liability insurance will cover the company in the event of accidental injury to clients by our business operation, in addition to damage to third party property while on business.

Products Liability to the value of \$5 million*

Product Liability insurance covers our legal liability (and associated costs) in respect of injury to any third party or loss of or damage to material property caused by any products supplied.

Notes & Grid Map

A series of horizontal dotted lines for writing notes.

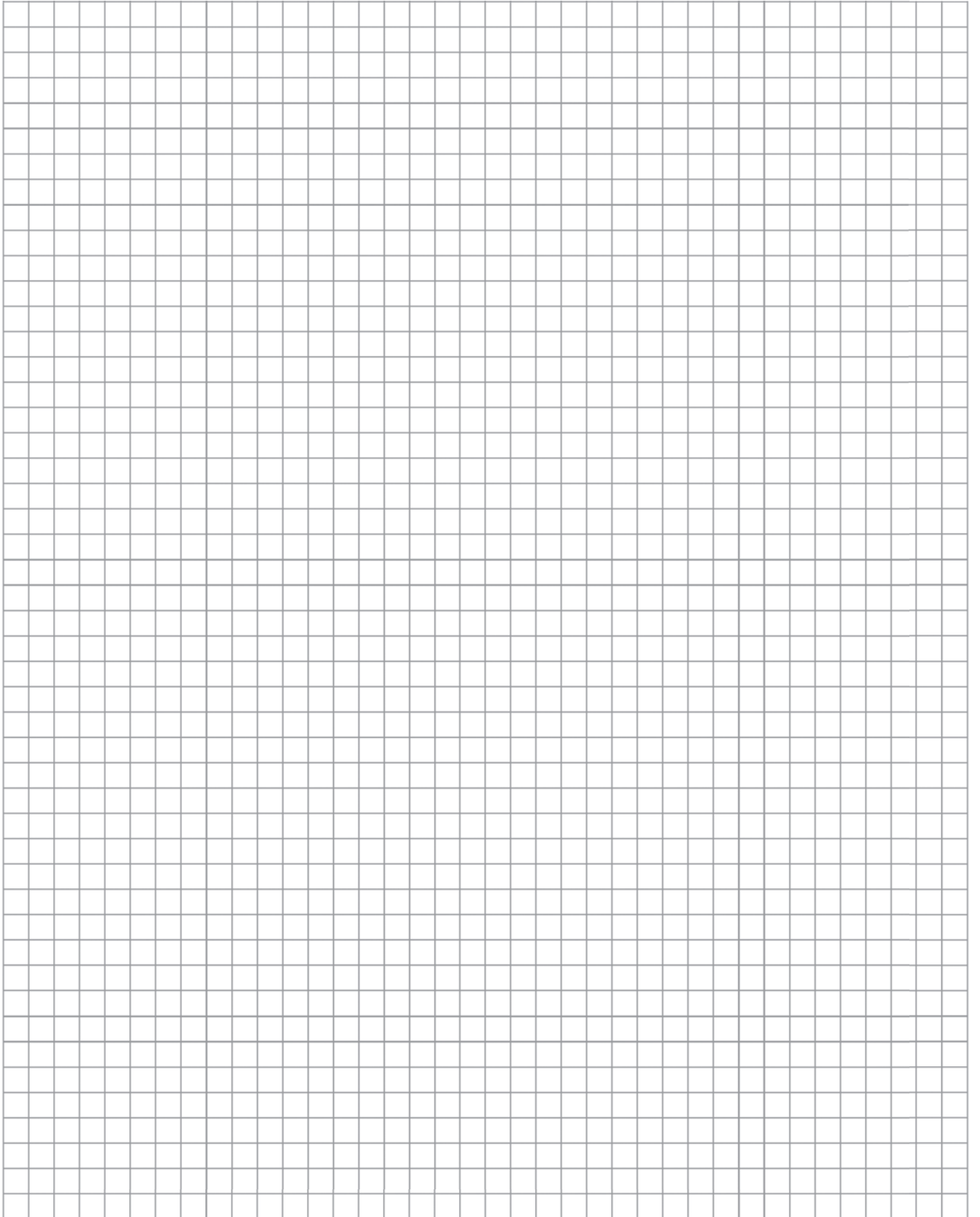



11 Fiveways Blvd
Keysborough
Victoria 3173
T: 1300 00 1800 or (+613) 9798 5111
F: (+613) 9798 5133
E: enquiries@huntheat.com.au
huntheat.com.au